

### Cabinet Knobs & Backplates

#### Cabinet Knobs

Fleur de Lis _____	1
Craftsman _____	1
Metropolitan _____	1
Round _____	2
Oval _____	2
Concentric _____	3
Railroad Spike _____	3

#### Cabinet Knob Back Plates

Fleur de Lis _____	4
Craftsman _____	4
Metropolitan _____	4
Round _____	5
Diamond _____	5
Square _____	5
Rectangle _____	5

### Wire Pulls

#### Fleur de Lis, Craftsman, Metropolitan

Fleur de Lis _____	6
Craftsman _____	6
Metropolitan _____	7

#### Rose Handle Wire Pulls

2" CTC _____	8
3" CTC _____	8
3 1/2" CTC _____	8
4" CTC _____	8
5" CTC _____	8
8" CTC _____	8
10" CTC _____	8

#### Plain Handle Wire Pulls

2" CTC _____	9
3" CTC _____	9
3 1/2" CTC _____	9
4" CTC _____	9
5" CTC _____	9
8" CTC _____	9
10" CTC _____	9

Contents Continued on Next Page

### Wire Pulls Continued

#### Wire Pulls with Backplates

3 1/2" CTC \_\_\_\_\_ 10

4" CTC \_\_\_\_\_ 10

### Twig Pulls

2" CTC \_\_\_\_\_ 11

3" CTC \_\_\_\_\_ 11

4" CTC \_\_\_\_\_ 11

5" CTC \_\_\_\_\_ 11

10" CTC \_\_\_\_\_ 11

### D Pulls

4 1/4" \_\_\_\_\_ 12

5 1/2" \_\_\_\_\_ 12

### Bin Pulls

BP10 \_\_\_\_\_ 13

BP20 \_\_\_\_\_ 13

CABINET HARDWARE

**FL162**  
Fleur de Lis 1 5/8"



**GC143**  
Craftsman 1 7/16"



**GC156**  
Craftsman 1 9/16"



**CC150**  
Metropolitan 1 1/2"



**MP162**  
Metropolitan 1 5/8"



**Backplates**

For Fleur de Lis, Craftsman and Metropolitan cabinet knob backplates, see page 4.

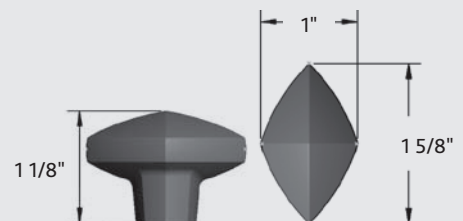
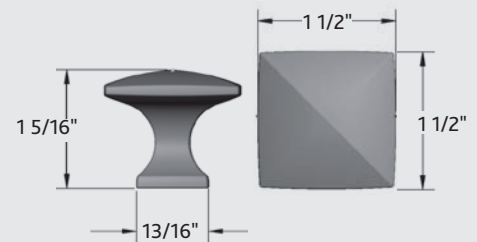
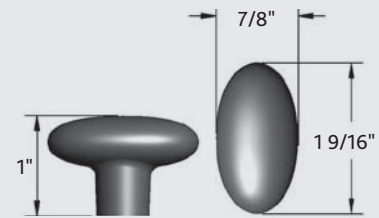
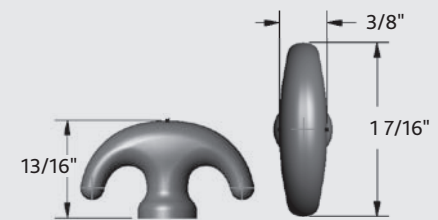
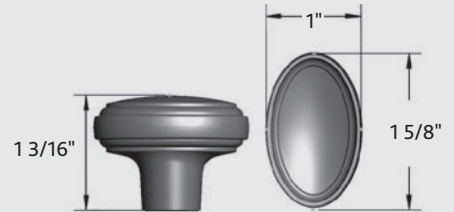

## CABINET HARDWARE

## Round & Oval Cabinet Knobs

**MC075**  
Round 3/4"



**MC125**  
Round 1 1/4"



**MC150**  
Round 1 1/2"



**PC125**  
Oval 1 1/4"



**PC162**  
Oval 1 5/8"



### Backplates

For cabinet knob backplates, see page 5.

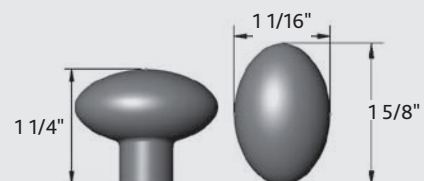
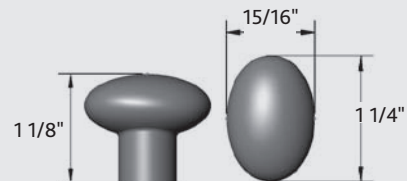
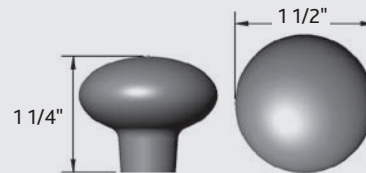
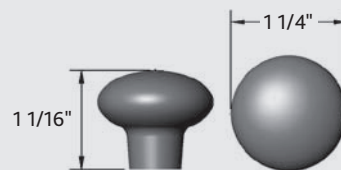
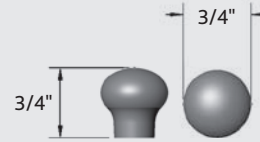

CABINET HARDWARE

**RC125**

Concentric 1 1/4"



**RC150**

Concentric 1 1/2"



**SC150**

Railroad Spike 1 1/2"



**Backplates**

For cabinet knob backplates, see page 5.

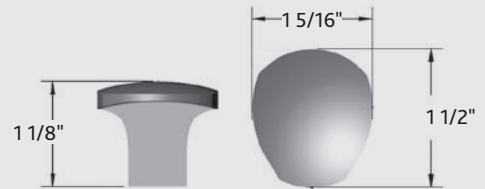
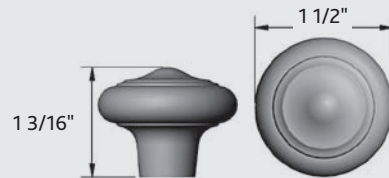
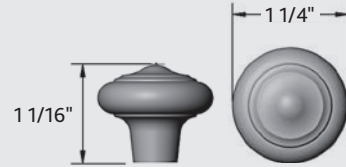

### CABINET HARDWARE

#### FB1710

Fleur de Lis 1 3/4" x 1"

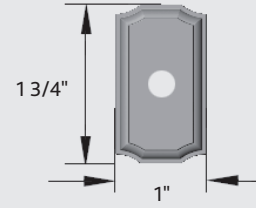
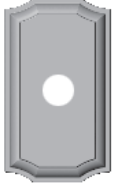

#### GB125

Craftsman 1 1/4" x 1 1/4"

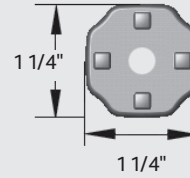

#### MB1510

Metropolitan 1 1/2" x 1"

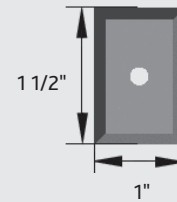

### CABINET HARDWARE

**BR100**  
Round 1"



**BS100**  
Square 1"

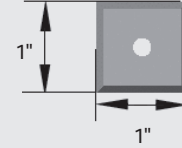
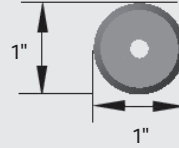

**BR125**  
Round 1 1/4"

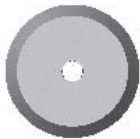

**BS125**  
Square 1 1/4"

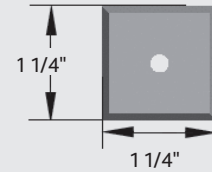
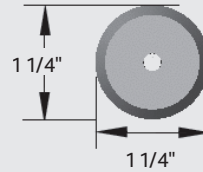

**BR150**  
Round 1 1/2"



**BS150**  
Square 1 1/2"

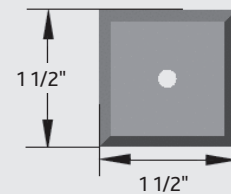
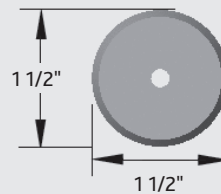
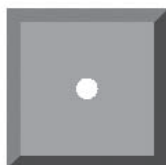

**BD3017**  
Diamond 3" x 1 3/4"



**B1510**  
Rectangle 1 1/2" x 1"

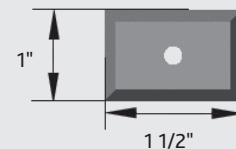
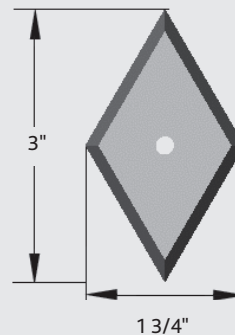

### CABINET HARDWARE

#### FWP40

Fleur de Lis Wire Pull 4" CTC



#### FWP40B

Fleur de Lis Wire Pull 4" CTC with Backplate



#### FB5010 (Fleur de Lis Back Plate)

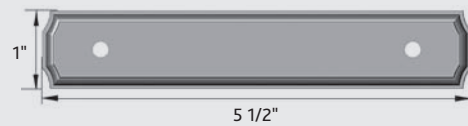

#### GWP40

Craftsman Wire Pull 4" CTC



#### GWP40B

Craftsman Wire Pull 4" CTC with Backplate

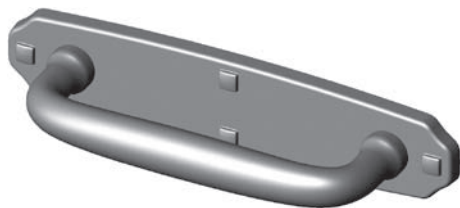

#### GB5712 (Craftsman Back Plate)

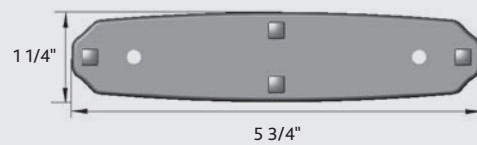

### CABINET HARDWARE

#### MWP40

Metropolitan Wire Pull 4" CTC

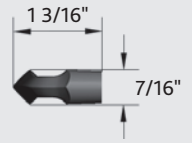
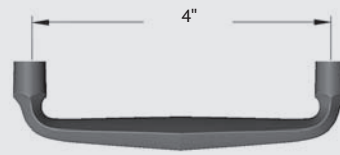

#### MWP40B

Metropolitan Wire Pull 4" CTC with Backplate



#### MB5010 (Metropolitan Back Plate)

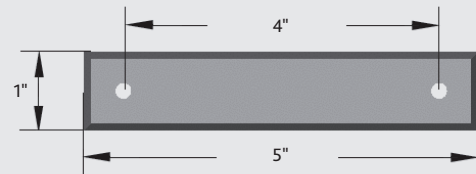

### CABINET HARDWARE

#### WP20R

Rose Handle 2" CTC

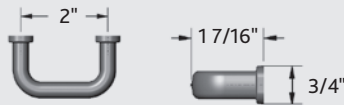

#### WP30R

Rose Handle 3" CTC

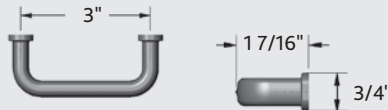

#### WP35R

Rose Handle 3 1/2" CTC

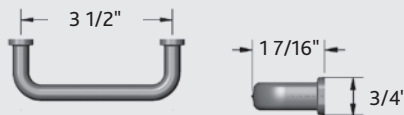

#### WP40R

Rose Handle 4" CTC

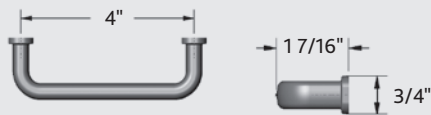

#### WP50R

Rose Handle 5" CTC



#### WP80R

Rose Handle 8" CTC



#### WP100R

Rose Handle 10" CTC

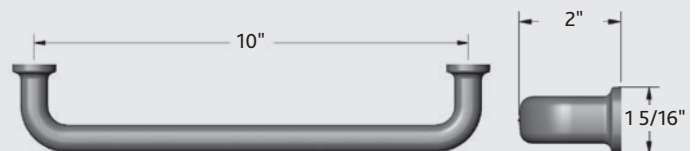

## CABINET HARDWARE

### WP20P

Plain Handle 2" CTC

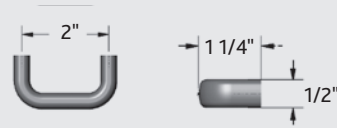

### WP30P

Plain Handle 3" CTC

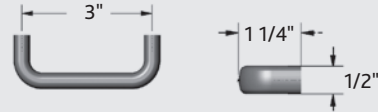

### WP35P

Plain Handle 3 1/2" CTC



### WP40P

Plain Handle 4" CTC



### WP50P

Plain Handle 5" CTC



### WP80P

Plain Handle 8" CTC



### WP100P

Plain Handle 10" CTC

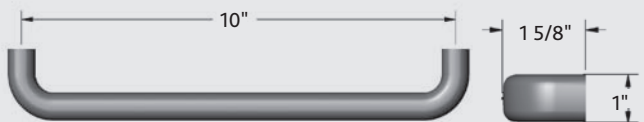

## CABINET HARDWARE

## Wire Pulls with Backplates

### WP35B

Wire Pull with Backplate 3 1/2" CTC

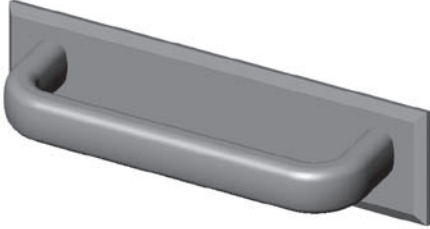

### WP40B

Wire Pull with Backplate 4" CTC

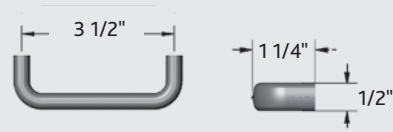
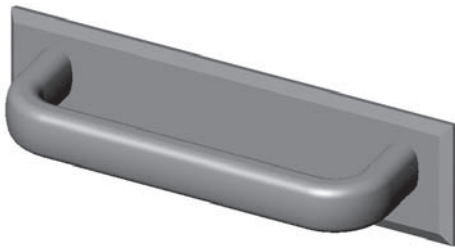

### B4510 - Backplate for 3 1/2" CTC Wire Pull

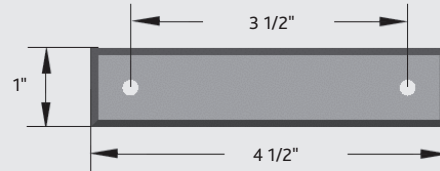

### B5010 - Backplate for 4" CTC Wire Pull

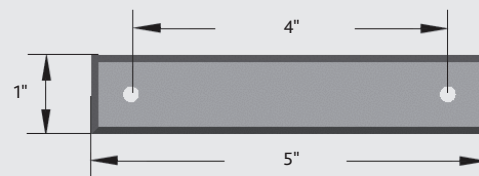

## CABINET HARDWARE

## Twig Pulls

### WPT20

Twig Pull 2" CTC

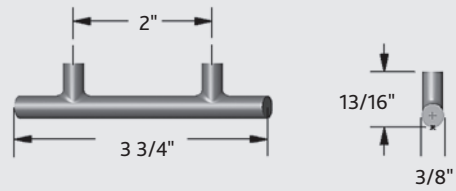

### WPT30

Twig Pull 3" CTC

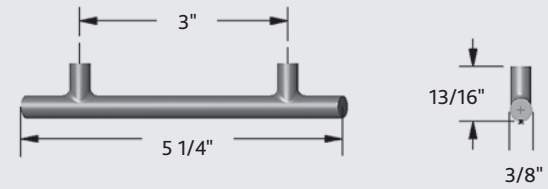

### WPT40

Twig Pull 4" CTC

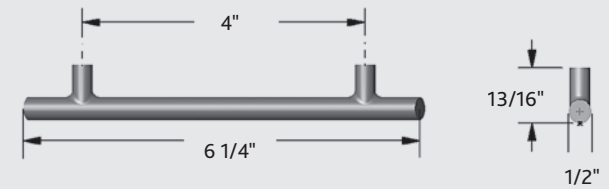

### WPT50

Twig Pull 5" CTC

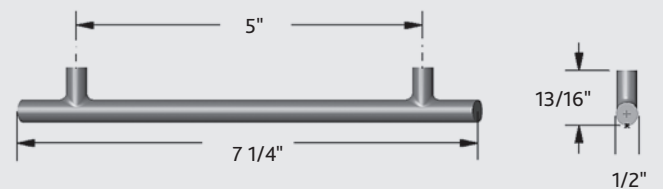

### WPT100

Twig Pull 10" CTC

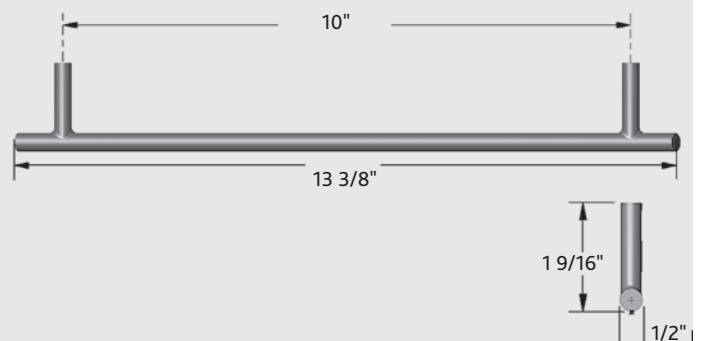
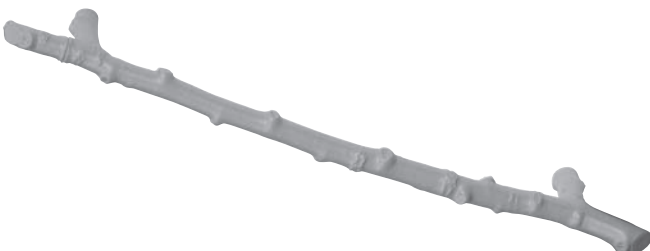

## CABINET HARDWARE

## D Pulls

**WSL10**  
D Pull 4 1/4"

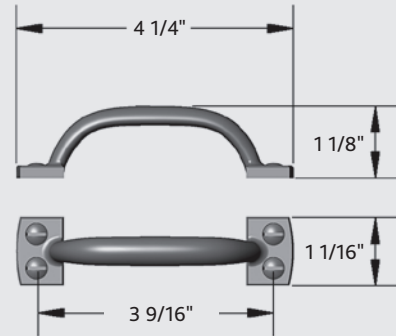

**WSL40**  
D Pull 5 1/2"

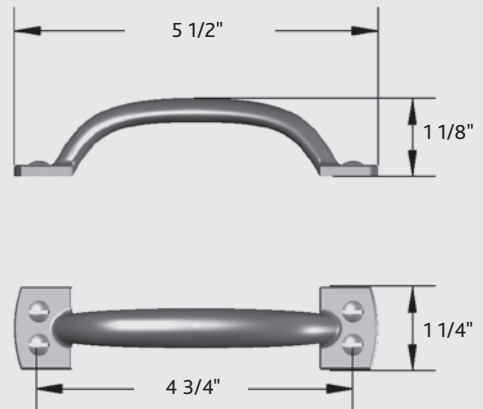
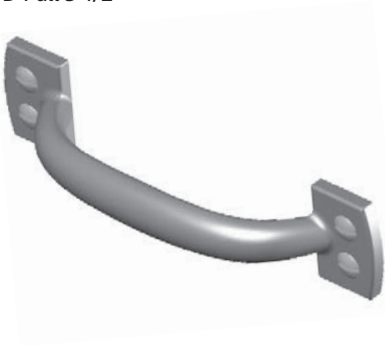

## CABINET HARDWARE

## Bin Pulls

### BP10

Bin Pull 4" x 1 1/2"

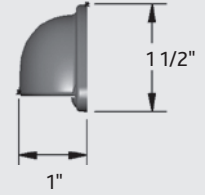

### BP20

Bin Pull 4" x 1 5/8"

